

Gainsborough

STANZA ELECTRIC SHOWER

INSTALLATION GUIDE



Register your shower today to activate
your FREE guarantee Call now on
0800 408 4864 Quoting GAGX771B

START | STOP

Can we help you? 01959 560760

Important information	3
- Safety information	3
- Connections	3
- Isolating valves	3
- Siting	3
- Pressures	3
- Pressure relief device	4
Product overview	4
Components	5
Pipework installation	6
Electrical installation	7
- Mains voltage connection	8
- Electrical rating	9
- Wiring installation	10
- Earth bonding	11
Showerhead installation	11
Front cover preparation	11
Front cover installation and shower commissioning	11
User instructions	13
Trouble shooting guide	14
Cleaning and maintenance	18
Cleaning the filter	18
Pressure test adapter fitting instructions	19

Important information

THIS INSTALLATION AND USER GUIDE IS DESIGNED TO ENSURE THE SAFETY OF THE INSTALLER AND USER AND THE OPERATION/RELIABILITY OF THE PRODUCT. FAILURE TO OBSERVE THESE MAY CAUSE A HAZARD, DAMAGE THE PRODUCT AND INVALIDATE YOUR GUARANTEE.

Safety information

This product must be installed by a competent person in accordance with all relevant current water supply regulations.

The electrical installation should be carried out by a qualified person in accordance with IEE (Institute of Electrical Engineers) wiring regulations (BS 7671) and certified to current building regulations. With reference to building regulation Part P, any new installation or replacement product installation which is not identical to the product being replaced, the cable sizes, circuit protection devices, earth bonding and all other requirements of the building regulation must be assessed by a (registered) qualified electrician and installed to the site conditions (see table in electrical rating).

THIS APPLIANCE IS NOT INTENDED FOR USE BY PERSONS (INCLUDING CHILDREN) WITH REDUCED PHYSICAL, SENSORY OR MENTAL CAPABILITIES OR LACK OF EXPERIENCE AND KNOWLEDGE UNLESS THEY HAVE BEEN GIVEN INITIAL SUPERVISION OR INSTRUCTION CONCERNING THE USE OF THE APPLIANCE BY A PERSON RESPONSIBLE FOR THEIR SAFETY. CHILDREN SHOULD BE SUPERVISED TO ENSURE THAT THEY DO NOT PLAY WITH THE APPLIANCE.

THE GAINSBOROUGH SHOWER IS SUITABLE FOR HOUSEHOLD USE ONLY

Connections

This shower unit is designed for use with 15mm British Standard pipe, and should be connected using a 15mm compression fitting (not supplied). Gainsborough Stanza is suitable for top, bottom or rear entry pipe work and cable connections. Supply lines should be flushed clear of any debris prior to installation of the unit.

Isolating valves

A suitable full bore isolation valve must be fitted to the incoming supply in accordance with the current water supply regulations and our terms of warranty.

Siting

The unit must be mounted on a flat, vertical finished wall with the hose pointing downwards. Any distortion of the back plate may result in the unit not working. Spacers are provided to enable the unit to be fitted to an uneven wall surface. DO NOT tile up to or use sealants around the unit. The shower is spaced off the wall by integral pillars to allow air circulation around the unit.

The casing must not be sited where it is subject to continuous spray from the shower head.

The unit must not be sited where it is likely to freeze.

WARNING: DO NOT SWITCH THE SHOWER ON IF THERE IS A POSSIBILITY THAT THE SHOWER COULD BE FROZEN. IF YOU HAVE SWITCHED THE SHOWER ON, SWITCH OFF IMMEDIATELY (Please refer to the troubleshooting guide page 14).

Pressures

Check that the dynamic (running) water pressure to the electric shower is adequate.

The required dynamic (running) pressure is:-

Maximum 1.0MPa (10 Bar)

Minimum 0.09MPa (0.9 Bar) at a flow rate of 8 litres per minute

Where pressures are likely to exceed 1.0MPa (10 bar), a pressure reducing valve must be fitted to the incoming mains supply. A setting of 0.3MPa (3 bar) is recommended. It should be noted that daytime pressures approaching 8 bar can rise above the stated maximum.

The use of other services connected to the water supply to the shower unit may cause the water pressure to drop below the minimum required. This should therefore be taken into consideration.

Pressure relief device (PRD)

To meet European standards, the shower unit features an integral pressure relief device (PRD). The PRD provides a degree of shower unit protection should an excessive build up of pressure occur within the shower.

DO NOT operate the shower with a damaged or kinked hose or blocked shower head, as this causes the PRD to operate. Failure to follow this instruction will invalidate the guarantee.

The shower will only function correctly with the hose and handset provided (see showerhead installations supplied with the kit). Failure to do so may result in the operation of the PRD and will invalidate the PRD guarantee. Please fully commission the shower prior to use following the instructions on page 12. Failure to do this could cause the PRD to operate and will invalidate the guarantee. The shower must be sited over a bath or shower tray as in the event of the PRD operating water will drain from the bottom of the shower unit.

Product overview

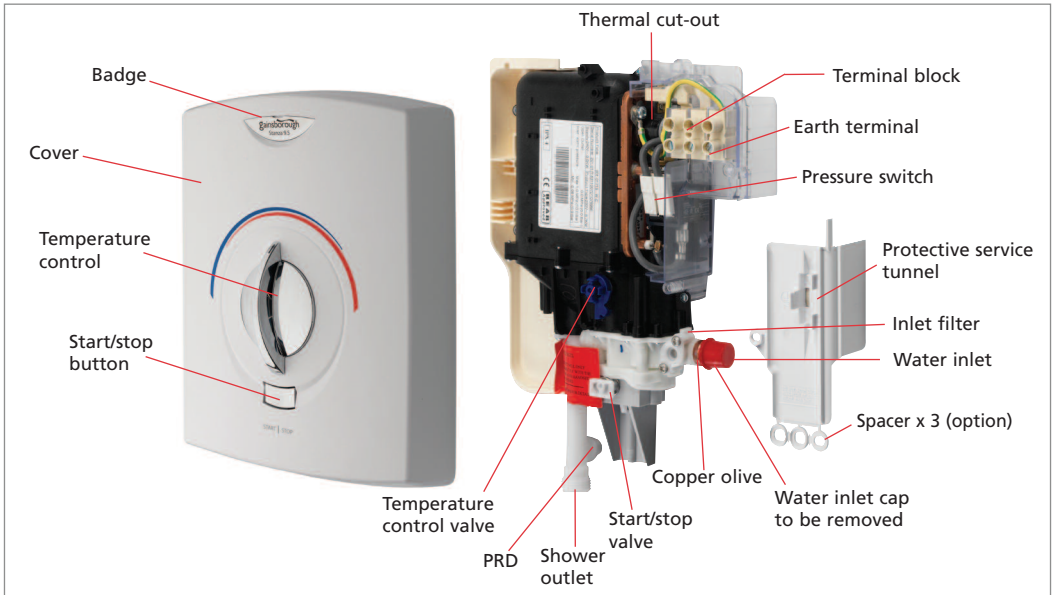

Shower components and features

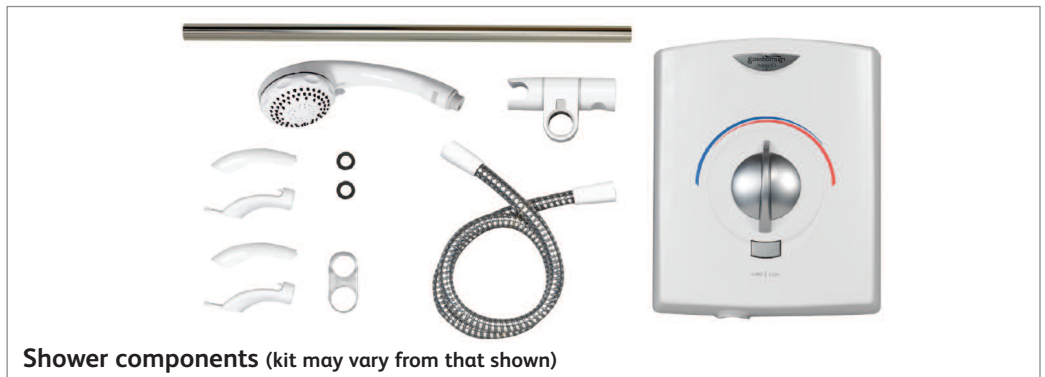

This product is supplied with a 1 year guarantee. If a defect that can be attributed to faulty design, materials or workmanship should arise with the product within the first year of purchase, the unit will be repaired or replaced at our discretion free of charge. Please retain your proof of purchase for inspection in the event of a claim during the guarantee period. In the event of any product problems, please contact the customer service helpline on 01959 560760 for assistance.

Pipework Installation instructions

! In addition to the guide that follows it is essential that the written instructions on pages 4 and 5 are read and understood, and that you have all the necessary components before commencing installation. Failure to install the product in accordance with these instructions may adversely affect the warranty terms and conditions. Do not undertake any part of this installation unless you are qualified to do so. Prior to starting, ensure you are familiar with the necessary plumbing and electrical regulations and legislation required to install the product correctly and safely.

Gainsborough reserves the right to revoke the terms of the warranty should access to the service connections be denied by the use of solid setting infill material.

1 Carefully remove the red outlet plug assembly.



2 Carefully remove the cover fixing screws (top and bottom). Carefully lift the casing up and away from the engine assembly. Remove the service tunnel and set aside. (This may be required if retrofitting this shower to an existing shower site).



3 Tape the template provided onto the finished wall surface in the desired position and mark the three fixing points. Drill and prepare the fixing holes using appropriate fixings.

4 If using top or bottom entry pipe work connection, fix the unit to the wall using appropriate screws (not supplied).

! The product **MUST** be fitted to give a level clearance between the wall and back plate assembly and spacers are supplied (fitted to the service tunnel) which can be fitted at one or all fixing points as required.

Failure to ensure a level clearance may cause the cover not to fit correctly, and the start/stop button or temperature control knob to be stiff or not operate correctly.

5 Once all pipe work has been completed flush through the water supply allowing it to discharge safely to waste.

Some modern fluxes can be extremely corrosive and, if left in contact will attack the working parts of this unit. All soldering must be completed and pipe work thoroughly flushed out in accordance with current Water Supply Regulations prior to connection of the product

Pipe work connection must be made using a 15mm compression elbow for top, bottom or rear entry (not supplied).

Please tighten connection to pipe work **BEFORE** tightening connection to shower inlet.

A copper olive is supplied located on the shower inlet stub and **MUST** be fitted into the compression elbow prior to the elbow being connected.

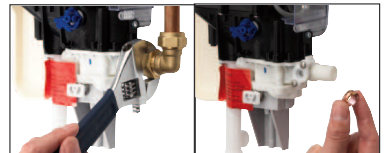

! **REAR ENTRY.** The wall must be sufficiently chased out around the pipe and cable to allow room for the nut on the compression elbow to be recessed into the wall. The pipe work must be connected to the elbow prior to fitting the shower unit to the wall.

6 Turn on the water supply to the shower unit and check for leaks up stream of the shower unit.

! If required, ensure the water pressure to the shower unit is within the minimum and maximum requirements by following the pressure testing detailed within the important information section (pressures).

Electrical installation

! BEFORE ANY ELECTRICAL CONNECTION IS ATTEMPTED, THE ELECTRICITY SUPPLY MUST BE TURNED OFF AT THE MAINS SWITCH. FAILURE TO DO SO COULD RESULT IN ELECTROCUTION.

The electrical installation should be carried out by a qualified person in accordance with IEE (Institute of Electrical Engineers) wiring regulations (BS7671).

THIS APPLIANCE MUST BE EARTHED.

IN THE INTERESTS OF ELECTRICAL SAFETY, A 30mA RESIDUAL CURRENT DEVICE (RCD) SHOULD BE INSTALLED IN ALL UK 230-240V ELECTRIC SHOWERS. THIS MAY BE PART OF A CONSUMER UNIT OR A SEPARATE UNIT.

A suitable double-pole isolating switch for supply disconnections must be incorporated in the fixed wiring circuit in accordance with current wiring rules. This must have a mechanical indicator showing when the switch is in the OFF position. A neon lamp alone is not sufficient. (see the electrical rating chart shown in the ELECTRICAL RATING SECTION). If it is fitted in the bathroom it must be a cord operated type. The switch must be readily accessible and clearly identifiable in zone 3 i.e. at 0.6m horizontally from the shower cubicle or edge of bath, or located above zone 2 (i.e. adjacent to the shower cubicle or edge of bath, but at least 2.25m from the floor) as detailed below. This requirement does not apply to the pull cord from the switch. See illustration.

Where shower cubicles are located in rooms other than bathrooms, any socket outlet in the room must be situated at least 3m from the shower cubicle and protected by a 30mA RCD.

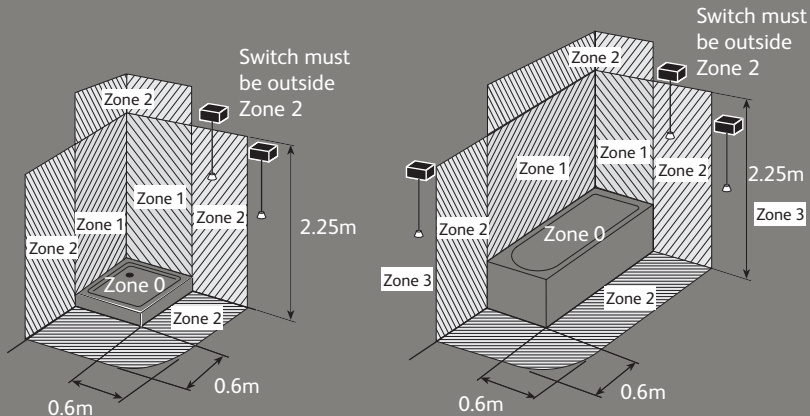

! YOUR ATTENTION IS ALSO DRAWN TO THE SAFETY INFORMATION DETAILED WITHIN THE IMPORTANT INFORMATION SECTION AND THE ELECTRICAL RATING SECTION. Page 9.

Mains voltage connection



Please refer to the typical system diagram shown below.

The following notes are for guidance only – the installation must comply with current regulations

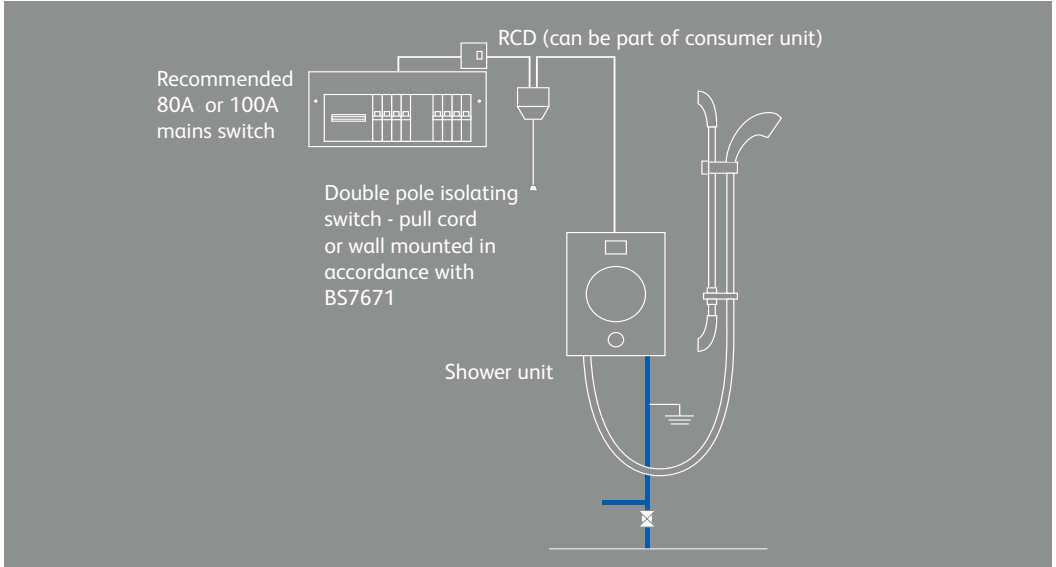

1 The shower unit must only be fitted to a 230-240V ac supply.

2 Before making any connections within the installation make sure that no terminal is live. If in doubt, switch off the whole installation at the consumer unit or switch fuse (where fitted).

3 The shower unit must be connected to its own independent electrical circuit. It **MUST NOT** be connected to a ring main, spur, socket outlet or lighting circuit, otherwise the circuit will overheat.

- 4** Check that the consumer unit (main fuse box):
- Has a main switch rating of 80A or above and
 - Has a spare fuse way which will take the fuse/mcb (miniature circuit breaker) that you need to fit
- If so you can wire the shower direct to the consumer unit (please refer to the typical system diagram above).
(Not all consumer units accept a 35/40/45A fuse sized fuse).

! If the consumer unit has a rating below 80A or if there is no spare fuse way, then the installation will not be straightforward. It may be necessary to install a new consumer unit to service the whole house or just the shower. A qualified person should install this. It may be necessary to contact the electricity supplier to upgrade the incoming supply.

Electrical rating

! Refer to the electrical rating diagram (shown below) to determine the nominal current of the shower. The current rating of the supply cable must be at least that of the shower itself. Use the chart to choose a fuse or mcb with a rating of less than that of your chosen cable.

Shower rating @ 240V		8.5kW		9.5kW		10.5kW	
Nominal current @ 240V		35.4A		39.6A		43.8A	
MCB rating		40A		40A		45/50A	
Cartridge fuse		40/45A		40/45A		45A	
		Min cable size mm ²	Max cable run in m	Min cable size mm ²	Max cable run in m	Min cable size mm ²	Max cable run in m
Type of cable run	Installed in insulated wall	10	61	10	55	10	50
	Conduit or trunking	6	37	10	55	10	50
	Clipped direct or buried in uninsulated wall	6	37	6	33	10	50

Notes:-

1. Cable selection is dependant on de-rating factors detailed in the notes below
2. In certain installations the combination of low voltage and extended cable lengths may result in loss of power and a consequential reduction in flow rates.
3. Above cable sizes are the minimum acceptable sizes. Sizes greater than these shown above may be used and should be used if cable runs are greater than indicated (above cable runs are based on a maximum 9.6v drop)
4. Rewirable fuses are not recommended and are not covered by this table.
5. Installation should be carried out by a qualified person. Please refer to BS7671 (Wiring regulations) if in doubt
6. A 16mm² cable may be required for long cable runs

Cables which are chased into the wall must be protected by the use of a conduit or sheathing. Surface mounted cables must also be protected by a suitable approved conduit.

If upgrading to a higher kW shower it is essential to ensure that the electrical circuit, including the wiring and isolating switches are adequate for the increased load.

The current rating will be reduced if the cable is:

- a. Bunched with others
- b. In an ambient temperature above 40c
- c. In an insulated wall or within thermal insulation, e.g. loft insulation
- d. In any other unusual position.

If in doubt about any aspect of electrical insulation, consult a qualified electrical engineer or the electricity supplier.

! WE STRONGLY RECOMMEND NOT USING REWIRABLE FUSES

Wiring installation

- 1 Loosen the terminal screws and insert the wires as indicated on the back plate moulding, then re-secure the terminal block screws. Ensure connections are tight and secure to prevent overheating. For most installations the removable service tunnel will not be required, enabling the earth connection to be made in the top right hand corner of the unit as illustrated.

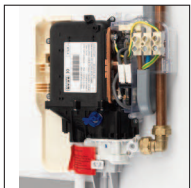

! If retro-fitting to an existing shower where the wiring cannot be connected as above, it may be necessary to utilize the service tunnel and alternative earth connection position.

- 2 Replace the service tunnel and secure using the fixing screw provided.

- 3 Unclip the earth terminal block and reposition it into the holder on the service tunnel.

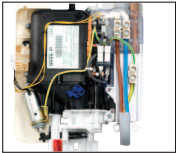
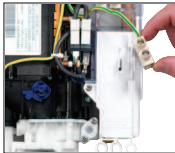

! Any cable MUST NOT have the outer insulation stripped back beyond the bottom of the back plate or service tunnel (if used) and must be protected from water by the protective cover shown in the diagram.

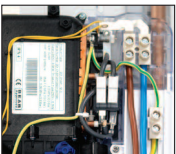
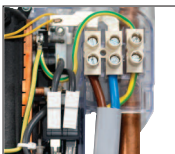

Earth bonding

- ! The installation must be earth bonded in accordance with current regulations
- Where earth bonding of the premises is not evident, it may be necessary to run a bonding cable back to the earth terminal at the consumer unit.

Shower head installation

- 1 The shower head should be sited close to the shower unit, not necessary on the same wall, but so that the unit is not subjected to continuous spray. The shower head should be sited so that it is no more than 610mm (2ft) above the bottom of the unit or no lower than 305mm (1ft) below the unit, when in its normal position in the shower head holder. Please see separate installation instructions supplied with the accessory kit for installation of handset, hose, rail and pillar pack.

! THE SHOWER OUTLET, HOSE AND HANDSET ACT AS A VENT, THEY MUST NOT BE BLOCKED, OBSTRUCTED OR HAVE CONNECTED TO THEM ANY FITTING INCLUDING HOSE OR HANDSET NOT APPROVED BY US. THE USE OF UNAPPROVED ACCESSORIES MAY INVALIDATE THE GUARANTEE AND MAY AFFECT THE PERFORMANCE AND SAFETY OF THE UNIT.

Front cover preparation

- 1 When the pipe work and electrical connections have been completed the front cover can then be prepared to be fitted prior to beginning the commissioning procedure.

- 2 Where a top or bottom entry supply configuration has been used, remove the relevant pipe work and cable entry point from the required section of the front cover, using a suitable tool. We recommend making good the cut out section using a round file. Ensure the front cover fits over the cables and pipes correctly. Ensure that only designated areas are cut.



- 3 Fix the self tapping screws a couple of turns into the fixing points at the top and bottom of the unit to aid locating the fixing points when securing the front casing to the back plate.



Front cover installation and shower commissioning

- ! Before use this shower must be fully commissioned following the procedure detailed overleaf. Failure to do so could damage the shower and invalidate the guarantee.

1 Without fitting the shower head or cover, connect the hose to the shower outlet to allow the water to discharge safely to waste.

! Ensure that the hose is straight and not kinked or bent (due to packaging).



2 Ensuring the electric supply remains isolated turn on the water supplies. Push the engine button in and wait until water runs through and out of the hose for a few seconds before depressing the engine button again.

NB Water will continue to flow for a few seconds after pushing the engine button to stop. This feature is called phased shut down.

Notice the internal pressure switches being activated after the button is pressed.

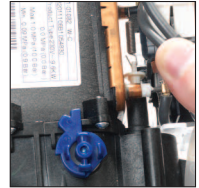

3 Attach the handset to the hose after passing it through the hose restraint (if required) and place in the handset holder in a position where it can spray safely. Depress the engine button again and wait until water sprays through the handset for a few seconds before depressing the engine button again.

4 Turn the flow control valve on the shower unit to full cold (6 o'clock position). Turn the temperature control lever on the front cover to the full cold position (9 o'clock). The flow control valve and lever are keyed and must be correctly positioned in order for the front cover to fit.

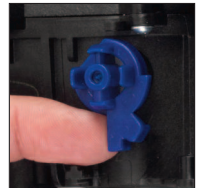

5 With the self tapping screws partially fitted to the fixing locations in the front casing, carefully offer it onto the engine assembly. The temperature control knob in the fully cold position, may have to be slightly adjusted to enable the keyways to align. Secure the front cover to the engine assembly using the 3 fixing screws taking care not to over tighten.



6 Rotate the temperature control knob and ensure it rotates smoothly. If not, the temperature control knob or cover may be fitted incorrectly.

The temperature control knob should then be positioned in the mid position (12 o'clock).

7 Turn on the electrical isolation switch. Press the start/stop button

Slowly turn the temperature control knob towards the hot position. The heater element should now be hotter and the temperature of the water should increase.

8

Adjust the temperature control knob to provide the desired temperature. Allow a few seconds after each adjustment for the temperature to stabilise. A cool shower can be achieved with the temperature control lever set towards the cold direction. The temperature will depend on the incoming water temperature and pressure.

9

When the unit is fully commissioned please remove the warning label on the front cover.

User Instructions

TO TURN ON AND SET THE TEMPERATURE

- 1 Turn on the isolating switch.
- 2 Press the start/stop button
3. Rotate the temperature control knob to give the desired temperature:

Clockwise for warmer and anticlockwise for cooler. Allow a few seconds after each adjustment for the temperature to stabilise.

ALWAYS CHECK THE SHOWERING TEMPERATURE BEFORE STEPPING INTO THE SHOWER. IT WILL TAKE APPROXIMATELY 20 SECONDS TO REACH A STABLE TEMPERATURE.

NOTE: SHOWERING TEMPERATURE MAY VARY/FLUCTUATE IF OTHER OUTLETS IN THE PREMISES ARE UTILIZED WHILE SHOWERING.

TO TURN SHOWER OFF

- 1 Press the start/stop button.
- 2 Turn off your isolating switch.

NB: The phased shutdown feature of this shower requires the shower to run on for a few seconds after the shower is turned off. This is a safety feature which flushes any residual hot water out of the shower unit to protect the next user.

SHOWER HEAD OPERATION

NEVER ATTEMPT TO MAKE ANY ADJUSTMENTS TO THE SHOWER HEAD BY PULLING ON THE SHOWER HOSE.

1. For full handset/kit operation please see individual instructions supplied in the kit box.



! These checks must only be performed by a competent person

Symptom	Possible cause	Action
Won't switch on/ switch off	Button mechanism not latching fully. Cover incorrectly fitted	Refit cover according to page 12 (front cover installation and shower commissioning section) checking for obstacles, ie cable, tiles. Use spacers provided to overcome uneven walls
No flow or Not enough flow (See also poor spray pattern below)	Water temperature control knob is turned fully clockwise Water turned off at mains or isolating valve SHOWER UNIT IS SUSPECTED OF BEING FROZEN There may be an outlet blockage Blocked inlet filter Inlet flow rate insufficient	Turn temperature control knob anticlockwise Ensure water supply is turned fully on at the mains and isolating valve. Ensure full bore isolation valve has been fitted. If so, DO NOT USE. a) Switch off immediately at the electrical isolation switch. b) Turn off at isolation valve. c) Contact our Customer Service Department. Disconnect handset from hose and run the shower a) If water flows then handset is blocked with scale or debris. Clean the handset and spray plate thoroughly. b) If the water does not flow, remove the hose from the shower unit a. If the water flows the hose is blocked. This could be due to damage, severe kinking or even an obstruction. The hose must be replaced with an approved hose. Contact our Customer Service Department b. If the water does not flow, there is a blockage in the plumbing to the shower, or the shower itself or the filter. c. Contact the Customer Service Department if you suspect the shower to be at fault. See details on front page Remove filter for inspection – refer to Cleaning and Maintenance section Check flow rate/pressure – see Important Information - Pressures section NB It is unlikely to achieve the requirements with a header tank

! These checks must only be performed by a competent person

Symptom	Possible cause	Action
Flow adequate but water too cold, or not hot enough.	Water flow too high	Reduce the flow by slowly turning the temperature control knob in a clockwise direction.
	No Electrical power getting to unit	Check isolator switched on, and remains on. Check MCB or fuse at consumer unit. Check RCD (if fitted). Check 230/240V at shower terminal block (Installer/ electrician only task). Possible wiring fault or poor connections.
	Pressure Switches not activating/ Low water pressure	Isolate electricity, remove cover and check switches come on (click) when water begins to flow. If not then check pipe work for potential blockages/ pressure losses. See Important Information - Pressures section and commissioning section Ensure the stop cock and servicing valves are fully open. If so ask the installer or the local water authority to check the running pressure is above the minimum required (see section Pipe Work Connections) This may be apparent during periods of high demand or when other outlet are used.
	Permanent thermal trip has operated	Shower has overheated. This is a non-user serviceable part, shower unit must be replaced.
	Sensitive adjustment	Carefully adjust dial waiting for temperature to settle in between changes.
Water too hot	Water flow too low	Increase the flow by slowly turning the temperature control knob in anticlockwise direction. Ensure the stop cock and servicing valves are fully open. If so ask the installer or the local water authority to check the running pressure is above the minimum required (see section Pipe Work Connections) This may be apparent during periods of high demand or when other outlet are used.

! These checks must only be performed by a competent person

Symptom	Possible cause	Action
Water too hot	<p>Spray plate blocked with scale or debris</p> <p>Water pressure too low.</p> <p>At times of high inlet temperature a cold shower may not be obtainable.</p>	<p>Clean handset spray plate - see cleaning and maintenance section</p> <p>Isolate electricity for shower at fuse box, remove cover and check switches come on (click) when water begins to flow. If not then check pipe work for potential blockages/ pressure losses. See Important Information - Pressures section page 4 and commissioning page 12.</p> <p>Check with installer or local water authority (See Important Information - Pressures section)</p>
Temperature varies dramatically while showering.	<p>Water pressure too low or unstable</p> <p>Thermal cut-out is operating, normally making a “click” as it does so.</p> <p>Over temperature device.</p>	<p>Check inlet requirements (see Important Information - Pressures section), and ensure no other main water devices are being used whilst showering</p> <p>Increase the flow by turning the temperature control knob in an anticlockwise direction. Check and clean the handset.</p> <p>Increase the flow by turning the temperature control knob in an anticlockwise direction. Shower has sensed high outlet temperature and is increasing the available flow to reduce temperature until the temperature dial is adjusted correctly.</p>
Poor spray pattern. (refer also to handset instructions)	<p>Partially blocked handset</p> <p>Multi pattern handset incorrectly set.</p> <p>Low water inlet temperature.</p> <p>Low voltage</p>	<p>Clean the handset - see cleaning and maintenance section</p> <p>Adjust the spray plate to improve the pattern</p> <p>Flow rate will naturally be lower when the inlet temperature is low, this applies to all electric showers.</p> <p>Consult electrician</p>

! These checks must only be performed by a competent person

Symptom	Possible cause	Action
Water runs from around hose (when shower is in use)	Pressure Relief Device (PRD) has operated due to excess pressure build-up. This has activated because of the Shower outlet is being reduced or blocked.	Ensure the correct supplied handset is used and clean from limescale. Turn off the electrical isolating switch and service valve – contact Customer Service Department.
	Hose incorrectly fitted.	Ensure hose is correctly fitted and tight.
Leaking	Inlet connection Leaking	Ensure compression fitting is correctly tightened and copper olive provided has been used.
Drip from shower head	Shower head draining	Tighten hose connections Remove outlet hose and see if drips from outlet pipe If so unit needs replacing, please contact customer services

Cleaning & maintenance

Your electric shower unit should be cleaned using only a soft cloth and washing up liquid.

DO NOT USE ABRASIVE CLEANERS.

To reduce the requirements for chemical descaling in hard water areas, the shower head incorporates rub clean teats. Any scale build up that may occur in any of the holes can be broken down by gently rubbing the flexible tips of the jets during use. This procedure should be completed regularly, as often as once a week in some hard water areas as scale build up can affect the spray pattern and cause the shower to perform poorly.

Should chemical descaling of the headset become necessary, remove the shower head and fully immerse in a mild proprietary descalent.

IT IS IMPERATIVE THAT DESCALING IS CARRIED OUT STRICTLY IN ACCORDANCE WITH THE MANUFACTURERS INSTRUCTIONS. SUBSTANCES THAT ARE NOT SUITABLE FOR PLASTICS AND ELECTROPLATED SURFACES MUST NOT BE USED.

Cleaning the filter

Cleaning the filter should only be completed by a qualified person.

1. Turn the electrical isolating switch off.
2. Isolate the water supply to the shower.
3. Carefully remove the fixing screws from the top and bottom of the front cover. Carefully pull the front cover away from the unit.
4. Unscrew the two screws on the filter protective cover and remove the filter assembly
5. Clean the filter assembly as necessary
6. Refit the filter assembly and protective cover. Reassemble the unit in reverse of the above procedure.



Pressure Test Adapter Fitting Instructions

To ensure the water pressure to the shower is adequate, we recommend adopting the following procedure: (Refer to important information pressures section for details of pressure required)

1. Isolate the electrical supply to the shower.
2. Isolate the water supply to the shower.
3. Remove the fixing screws from the top and bottom of the front cover. Carefully pull the front cover clear.
4. Remove the pressure test adaptor from the inside of the front cover.
5. Unscrew the two fixing screws on the filter and remove the filter assembly.
6. Replace the filter assembly with the pressure test adaptor and secure into place using the filter assembly fixings.
7. Connect a pressure testing device to the adaptor (not supplied).
8. Ensuring the electrical supply remains isolated, turn on the water supply to the shower.
9. Push plunger and wait until water runs through to the shower unit.
10. Check the reading on the pressure testing device is within the minimum and maximum requirements stated above.
11. Isolate the water supply to the shower.
12. Detach the pressure test device and remove the adaptor.
13. Refit the filter assembly and secure using the fixings.
14. Refit the pressure test adaptor into the fixing position within the front cover.
15. Reassemble the unit in reverse of the above procedure and turn on the water and electrical supplies to the shower unit.

The Waste Electrical and Electronic Equipment (Producer Responsibility) Regulation 2004

This product is outside the scope of the European Waste Electrical and Electronic Equipment Directive as interpreted within the UK.

In the UK this product can therefore be disposed of through commercial non-WEEE waste facilities.

The original manufacturer does not accept any liability under the WEEE directive within the UK.

In other EU countries the WEEE directive may apply and, at end of life, product must be disposed of at a suitable WEEE recycling centre



Gainsborough Bathroom Products Limited
Customer Service Department
The Flyer's Way
Westerham
Kent
TN16 1DE

Customer helpline: 01959 560760

Fax: 01959 560030

Registered in England & Wales

Registration Number 05221544

www.gainsboroughshowers.co.uk

e-mail: enquiries@gainsboroughshowers.co.uk